

Building and Sailing the *San Salvador*



Nova et vna Terrarum et regionum Californiarum ac insularum
Mexicanae et Novae, per com. mag. Christoph. colum. Sen. Sen.
Mexicanae, ad Hispan. Cuba. reg. reg. Mexicanae ad vna cartam
delimitata. A. M. Titiana. auctore. Geographo. edas.

Reverend. Mag. Christoph. Columbus.
1492

CAPASCHI

Tontontec

CEVOVA

NOVA

Suala mons

GRANADA

Tagil

FLORIDA

TERCH'S

COSSA



Topira

SINUS MEXICANUS

CALIFORNIA

MARE

COSSA

CANA

TOVA

Circulus

Cancin

GALLITIA

PANCO

NOVA

HISPANIA

CUBA

FONDURAZ















San Salvador
Maritime Museum













26⁺
PL SC
W/L 12
W/L 14
2.5/2.5 SC
3.5/3.5 SC
4.5/4.5 SC

28⁺
PL SC
W/L 12
W/L 14
2.5/2.5 SC
3.5/3.5 SC
4.5/4.5 SC

30⁺
W/L 12
W/L 14
2.5/2.5 SC
3.5/3.5 SC
4.5/4.5 SC

PL SC
W/L 12
W/L 14
2.5/2.5 SC
3.5/3.5 SC
4.5/4.5 SC

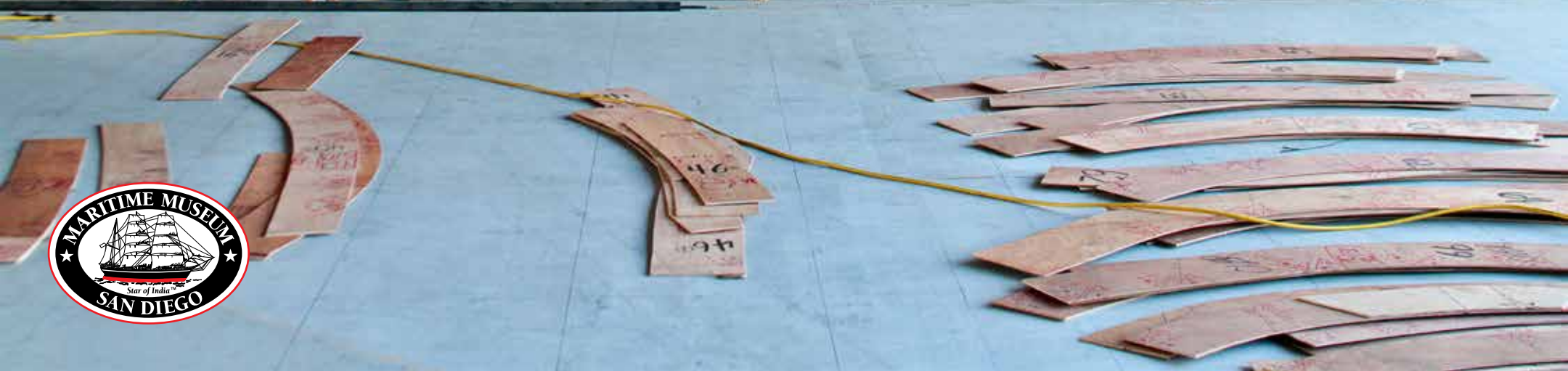

























































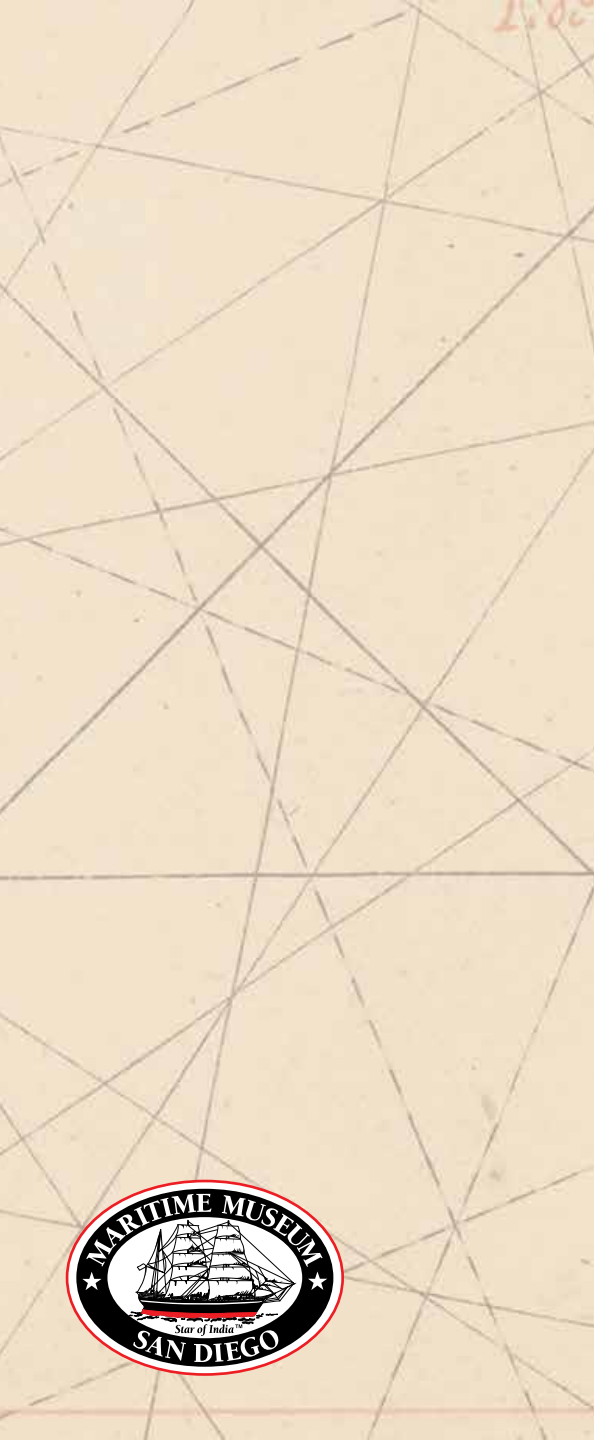

















48











© 2012 Ted Walton Photography























© Jerry Seto



HDX



© Jerry Sato



© Jay Seto



© Jerry Selt



© Jerry Selt





© Jerry Soto



© Jerry Soto





















XII
XI
X
IX
VIII
VII



© 2015 TED WALTON
FAB INC.



PYS 1

Pacific Taylor Service

HARBOR CAPTAIN





B. de S. Symon

Punta de S. Barthol

Sirra Pintado

P. de Roque

B. de

Punta de S. Apalma





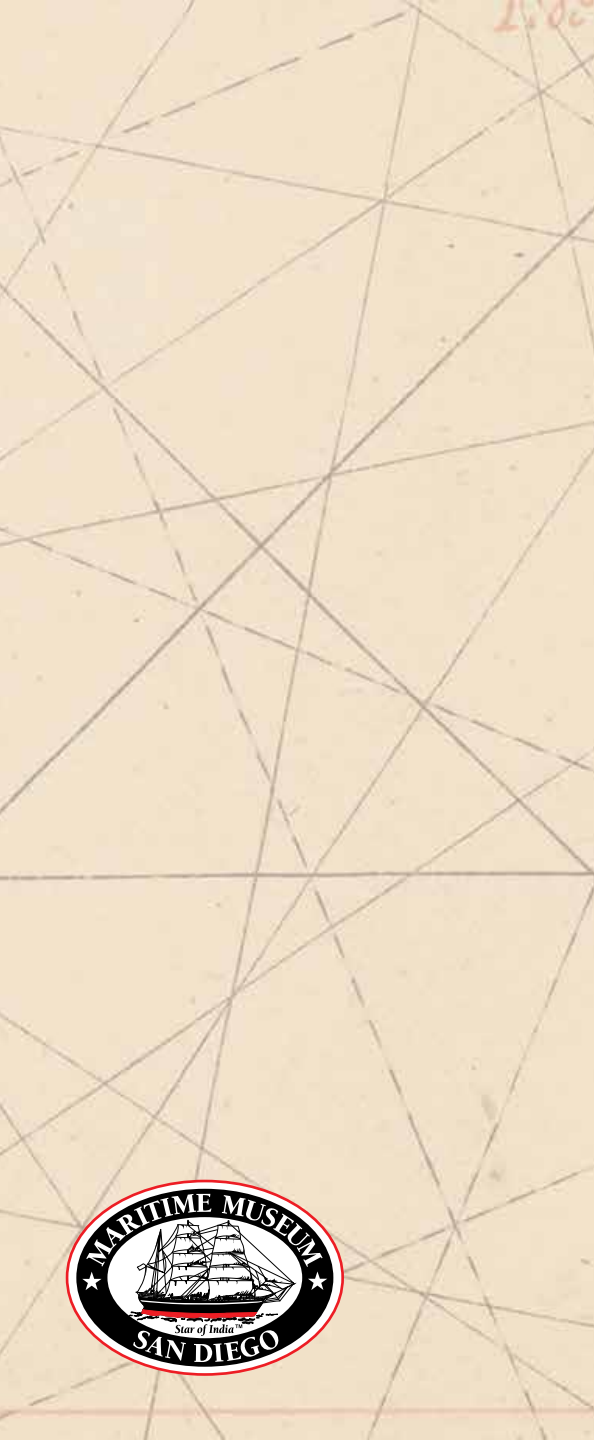

B. de S. Symon

Punta de S. Bartholomew

Sierra Pintada

P. de Roques

B. de

Punta de S. Apalma



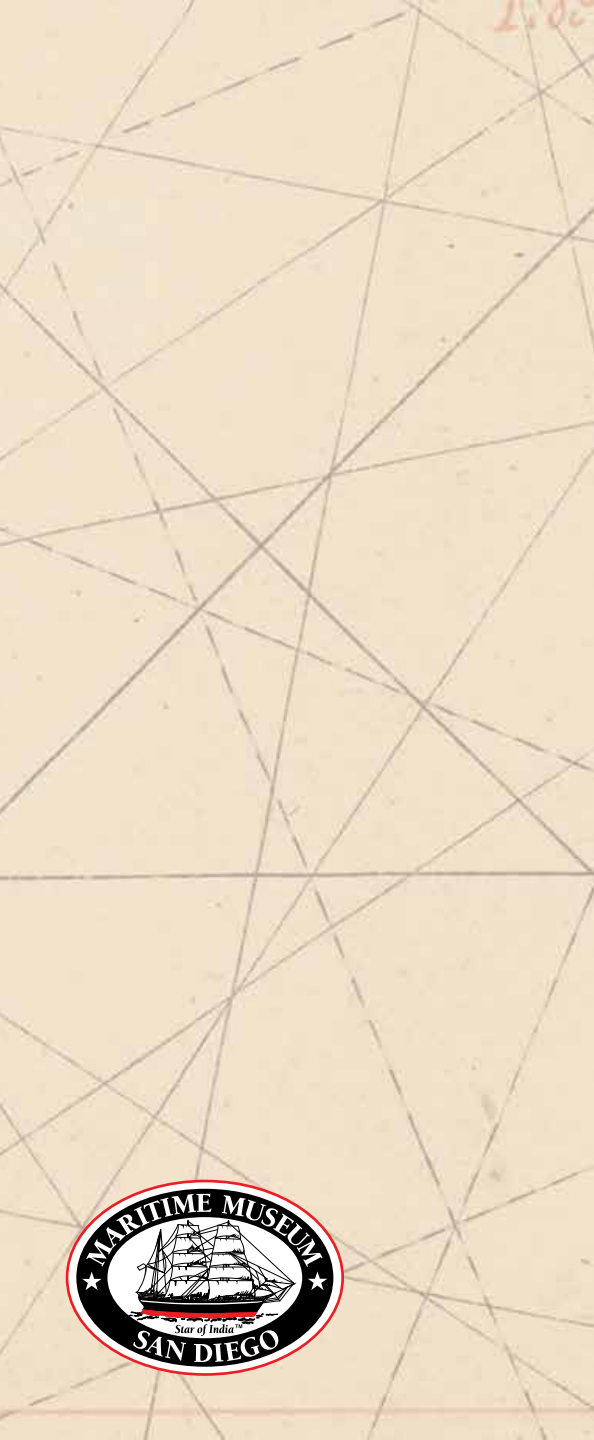

















Michael Kusley
PHOTOGRAPHY



Michael Brodey
PHOTOGRAPHY





















☰ MENU

↶ Share



 AVALON, CA
59°
High: 66° Low: 54°





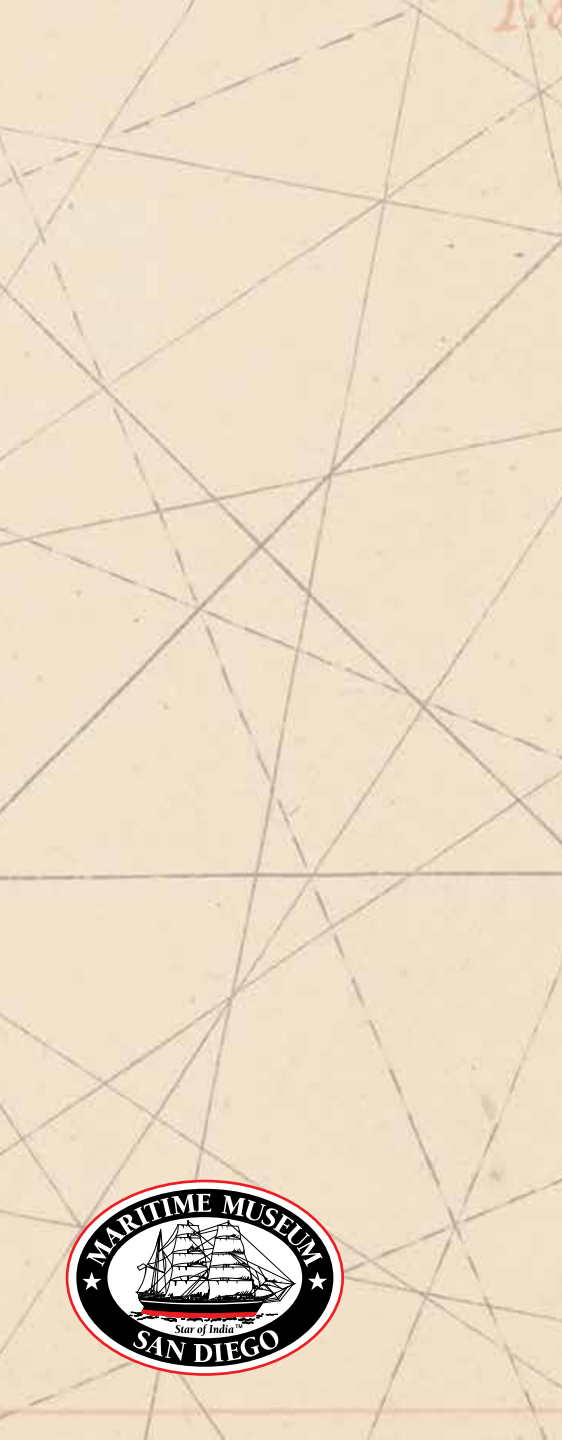









@k.st









GO TO LIST

CURSOR

POINTS ROUTE

CANCEL DATA VOL

DISP MENU GAIN TX

OUT RANGE IN

CTRL

SCROLLING SHIP 3D

SAVE MOB

BRIGHT



FURUNO UNIVERSAL AIS









© Ted Walton Photography









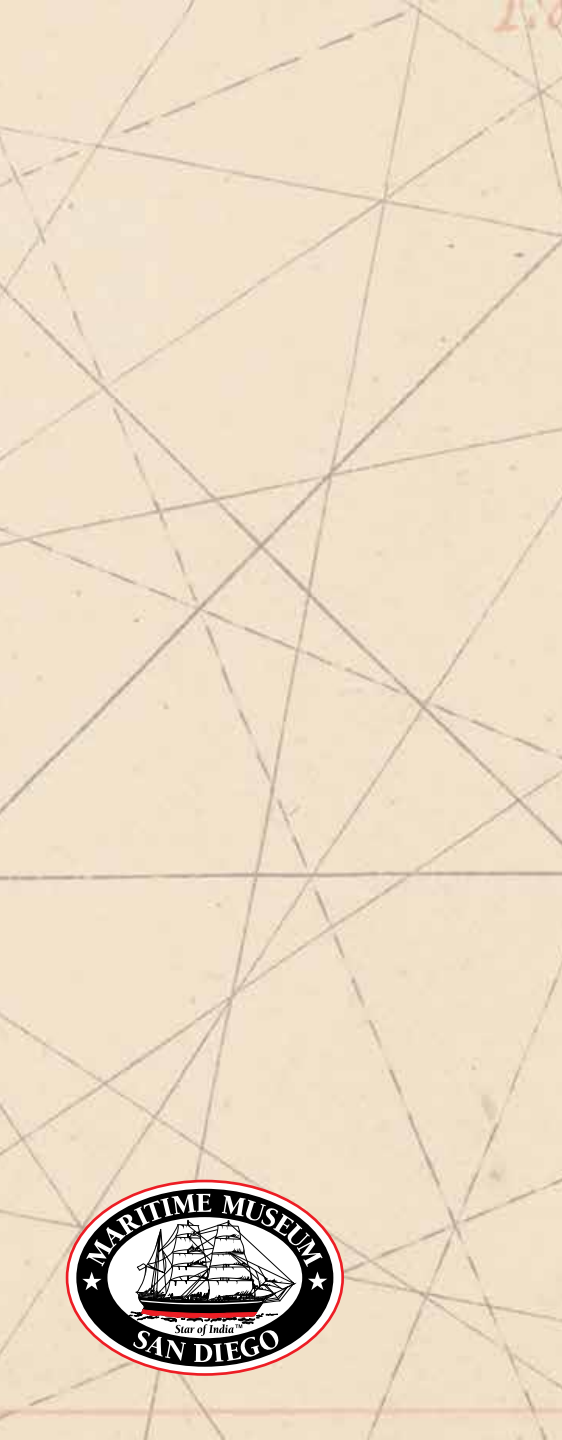

© 2014 Wikimedia Commons

Salvador

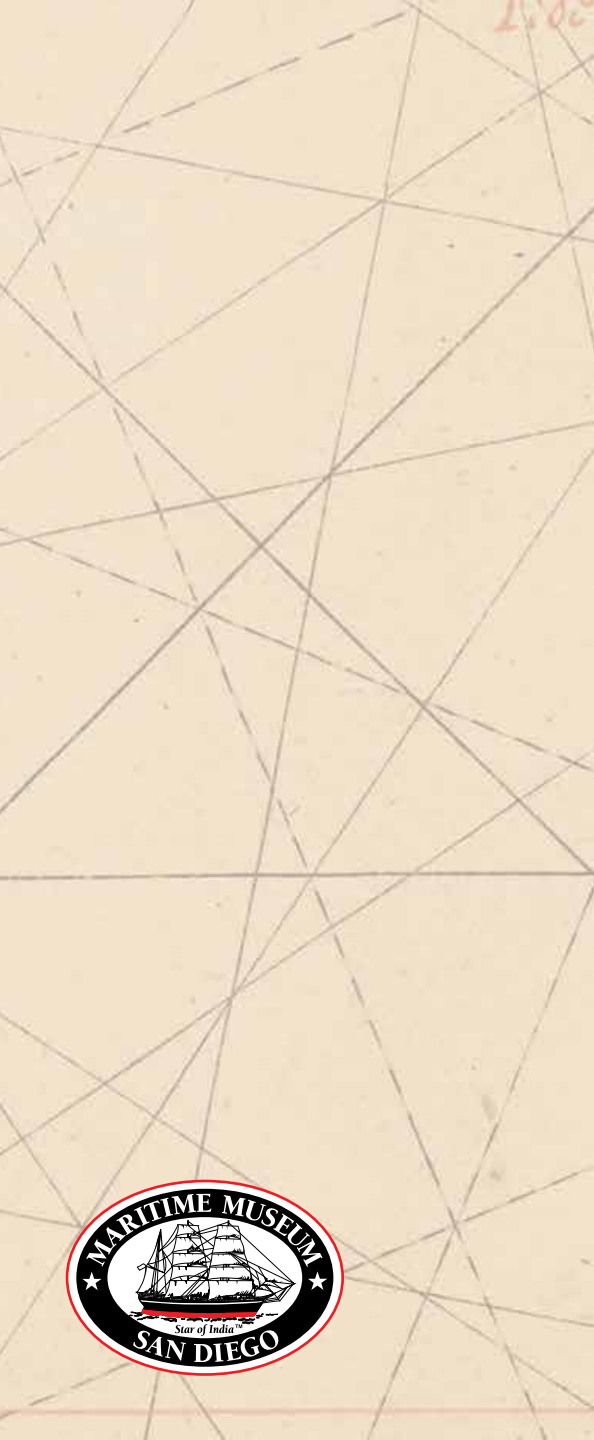





© 2014 Maritime Museum San Diego

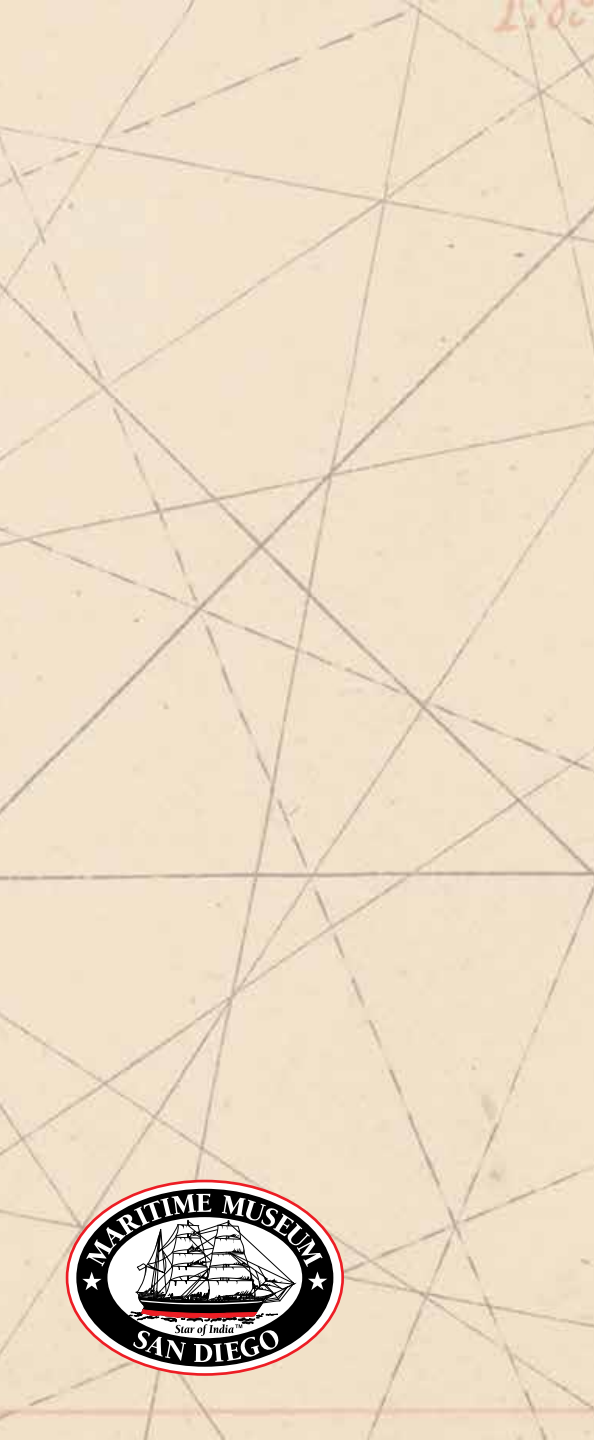









© Ted [unreadable] [unreadable]



San Salvador
Build Crew

The Revenue Cutter

MARITIME MUSEUM



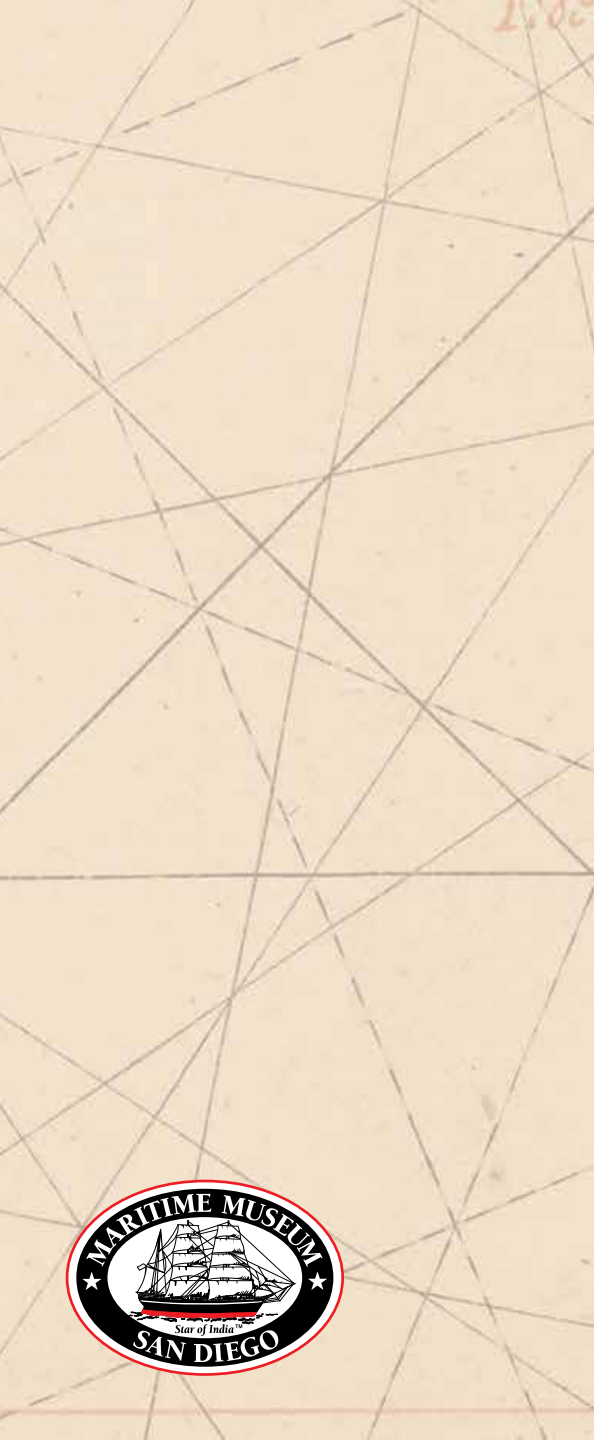



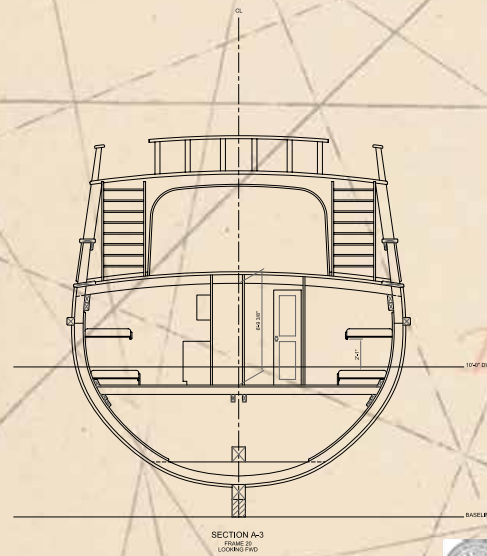
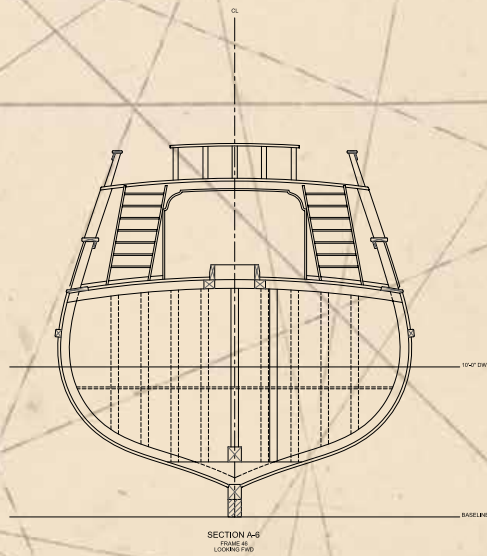
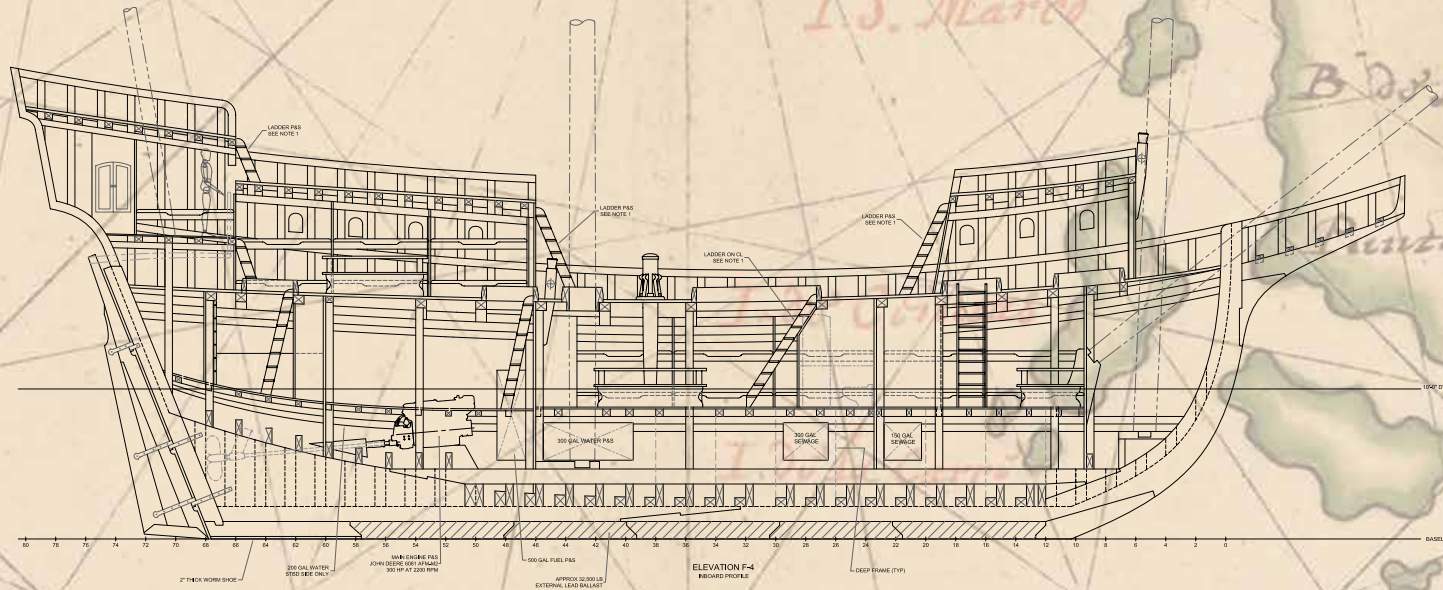

GENERAL NOTES
 1. HANDRAILS TO BE INSTALLED ON LADDERS ACCESSIBLE TO PASSENGERS. HANDRAILS TO BE LOCATED 30 INCHES ABOVE TREADS.

NO.	DATE	DESCRIPTION	BY
1			
2			
3			
4			
5			
6			
7			
8			
9			
10			
11			
12			
13			
14			
15			
16			
17			
18			
19			
20			
21			
22			
23			
24			
25			
26			
27			
28			
29			
30			
31			
32			
33			
34			
35			
36			
37			
38			
39			
40			
41			
42			
43			
44			
45			
46			
47			
48			
49			
50			
51			
52			
53			
54			
55			
56			
57			
58			
59			
60			
61			
62			
63			
64			
65			
66			
67			
68			
69			
70			
71			
72			
73			
74			
75			
76			
77			
78			
79			
80			
81			
82			
83			
84			
85			
86			
87			
88			
89			
90			
91			
92			
93			
94			
95			
96			
97			
98			
99			
100			



PROJECT NO. 08-SS
 PROJECT NAME S/V SAN SALVADOR
 SHEET NO. 16-00-100
 SHEET TITLE INBOARD PROFILE AND SECTIONS
 DATE 04/20/10
 DRAWN BY [Name]
 CHECKED BY [Name]
 APPROVED BY [Name]





I.S. Marco

B. de S. Simon

Punta de S. Barthol

Sirra Pintado

P. de Roque

B. de

Punta de S. Apalma

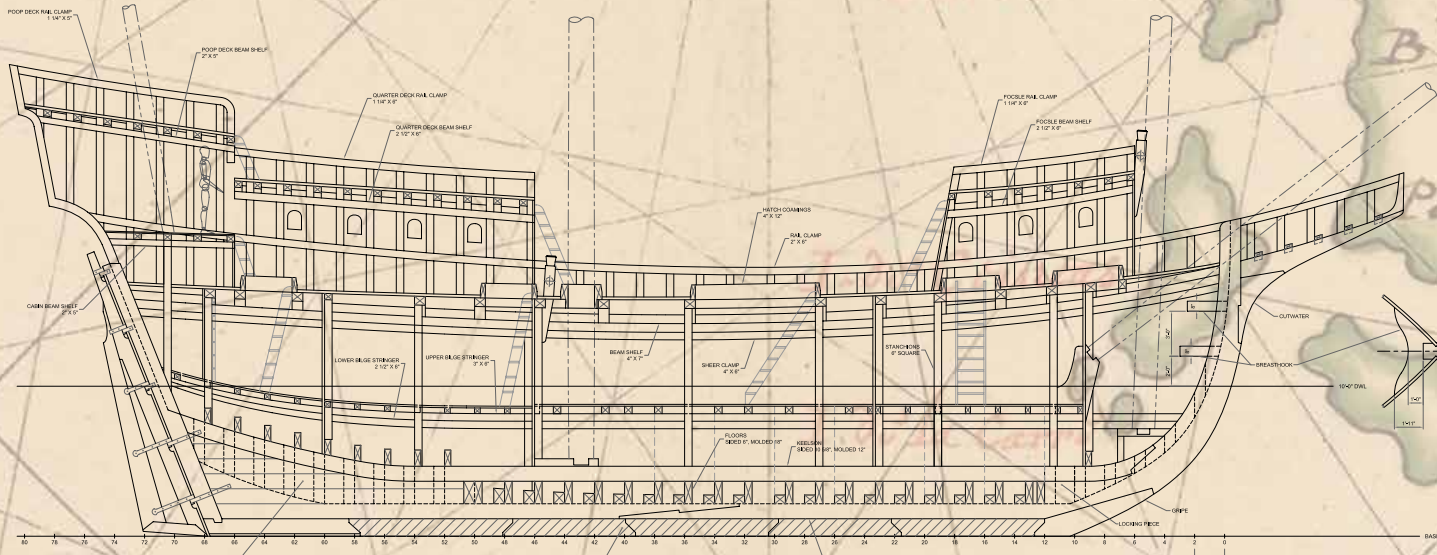

ELEVATION B-5 CONSTRUCTION PROFILE

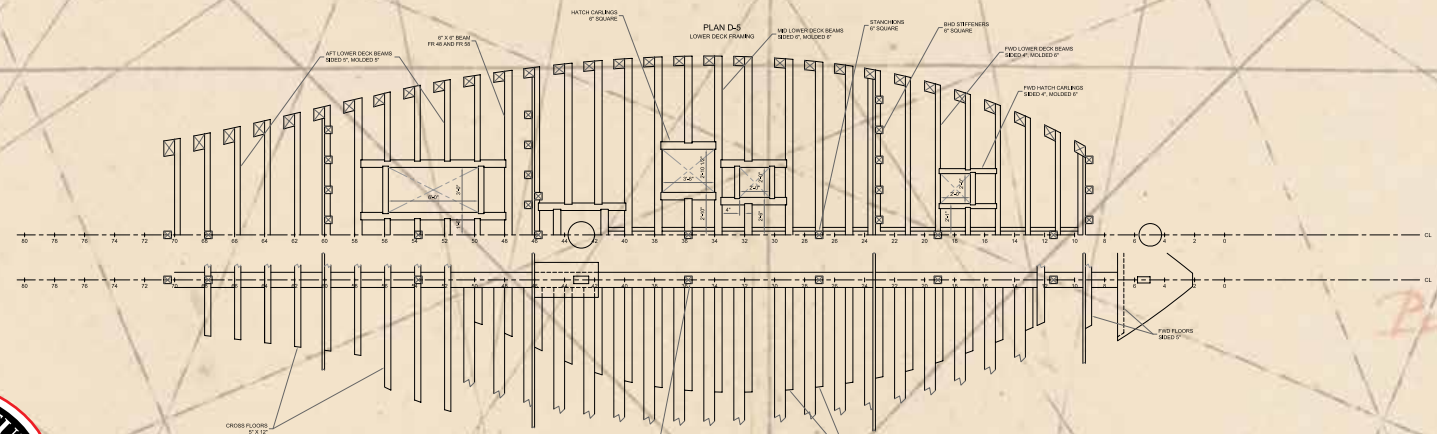

PLAN B-5 BOTTOM FRAMING



NO.	DATE	DESCRIPTION	BY
1			
2			
3			
4			
5			
6			
7			
8			
9			
10			
11			
12			
13			
14			
15			
16			
17			
18			
19			
20			
21			
22			
23			
24			
25			
26			
27			
28			
29			
30			
31			
32			
33			
34			
35			
36			
37			
38			
39			
40			
41			
42			
43			
44			
45			
46			
47			
48			
49			
50			
51			
52			
53			
54			
55			
56			
57			
58			
59			
60			
61			
62			
63			
64			
65			
66			
67			
68			
69			
70			
71			
72			
73			
74			
75			
76			
77			
78			
79			
80			
81			
82			
83			
84			
85			
86			
87			
88			
89			
90			
91			
92			
93			
94			
95			
96			
97			
98			
99			
100			

SHARP DESIGN

PROJECT AT ADDRESS, BOOTH NO. 2300-9146, 13750 JENSEN RD., SAN DIEGO, CALIFORNIA, USA 92130

TEL: 619 521-1111 FAX: 619 521-1111

PROJECT NO. 08-SS1 PROJECT NAME S/V SAN SALVADOR

DATE 08-01-10 DRAWN BY [Signature] CHECKED BY [Signature] SCALE 1:100 SHEET NO. 08-00-101









San Salvador
Three Masters of the Age

XII
XI
X
IX